

Warning :

- Be sure to check all packing material carefully for small parts, which may have come loose inside the carton during shipment.
- To prevent possible scratches and damage, this furniture must be assembled on a soft surface such as a blanket or carpet.

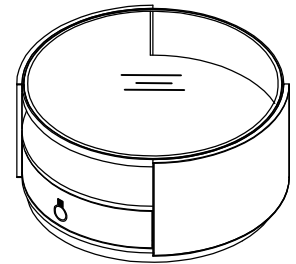

Components and Hardware List

<p>Glass</p> <p>(A) 1 pc.</p>	<p>Round Cocktail Table</p> <p>(B) 1 pc.</p>	<p>Caster</p> <p>(C) 4 pcs.</p>	<p>Open Wrench 16mm</p> <p>(D) 1 pc.</p>
-------------------------------	--	---------------------------------	--

50203
Round Cocktail Table

Screw Driver
not included

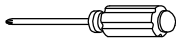

STEP 1:

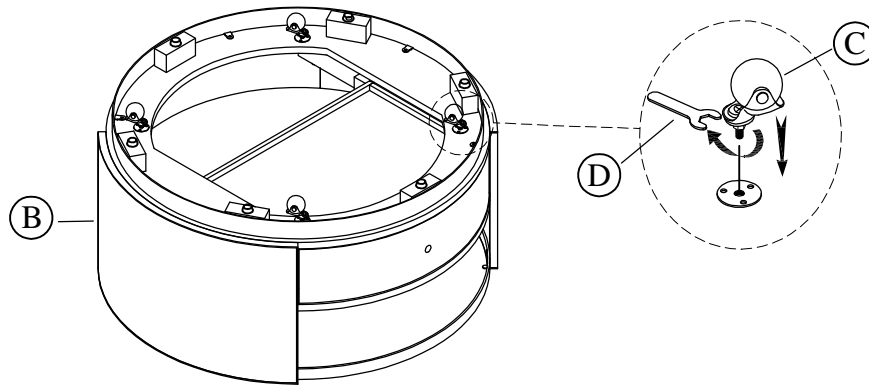

STEP 2:

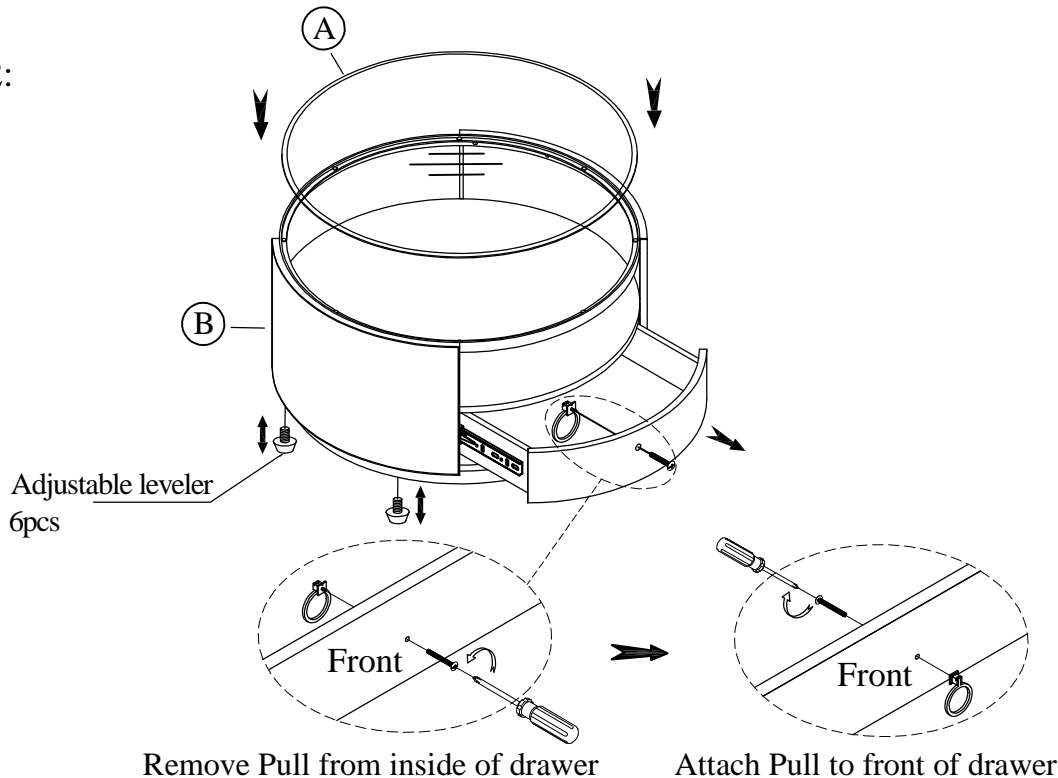

The casters provide an element of convenient mobility, however, to prevent possible damage to some types of flooring, never roll casters on unprotected hardwood or vinyl flooring.